

DIMENSIONS

NO: S6HDG275030-00

MODEL: 80HDG25.5 & 100HDG25.5 / 27.5 & 150HDG25.5 / 27.5

50Hz 3Ø

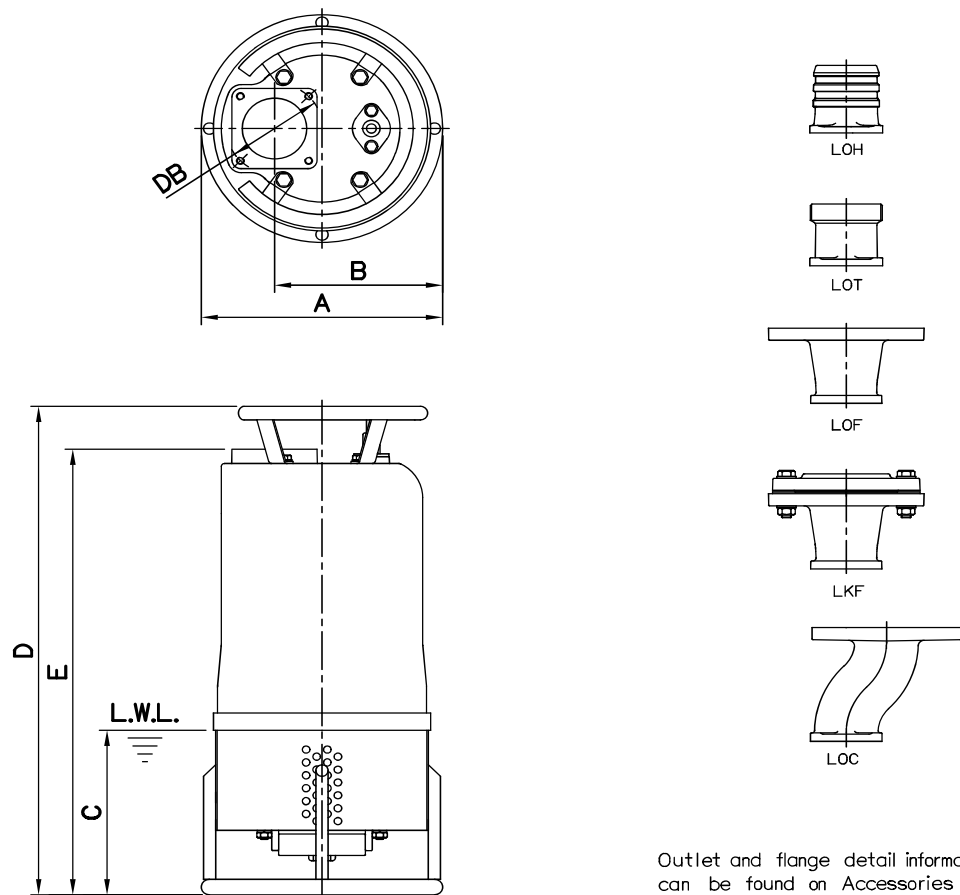

Outlet and flange detail information can be found on Accessories section.

Dimensions-mm

Weight:kg

Model	A	B	C	D	E	DB	WT1	Optional Outlet Accessories				
								LOH	LOT	LOF	LKF	LOC
80HDG25.5	318	221	200	683	623	127	73	LOH3-127	LOT3-127	LOF3-150-160*127	LKF3-150*127	LOC3-150*127
100HDG25.5	318	221	200	683	623	127	76	LOH4-127	LOT4-127	LOF4-175-190*127	LKF4-175*127	-
100HDG27.5	318	221	200	683	623	127	81	LOH4-127	LOT4-127	LOF4-175-190*127	LKF4-175*127	-
150HDG25.5	318	221	200	683	623	127	79	LOH6-127	LOT6-127	LOF6-240*127	LKF6-240*127	-
150HDG27.5	318	221	200	683	623	127	82	LOH6-127	LOT6-127	LOF6-240*127	LKF6-240*127	-

Dimensions-inch

Weight:lb

Model	A	B	C	D	E	DB	WT1	Optional Outlet Accessories				
								LOH	LOT	LOF	LKF	LOC
80HDG25.5	12½	8⅞	7⅞	26⅞	24½	5	161	LOH3-127	LOT3-127	LOF3-150-160*127	LKF3-150*127	LOC3-150*127
100HDG25.5	12½	8⅞	7⅞	26⅞	24½	5	168	LOH4-127	LOT4-127	LOF4-175-190*127	LKF4-175*127	-
100HDG27.5	12½	8⅞	7⅞	26⅞	24½	5	179	LOH4-127	LOT4-127	LOF4-175-190*127	LKF4-175*127	-
150HDG25.5	12½	8⅞	7⅞	26⅞	24½	5	174	LOH6-127	LOT6-127	LOF6-240*127	LKF6-240*127	-
150HDG27.5	12½	8⅞	7⅞	26⅞	24½	5	181	LOH6-127	LOT6-127	LOF6-240*127	LKF6-240*127	-

L.W.L.:Lowest Running Water Level

WT1:Pump Weight(Without Cable)

DIMENSIONS

NO: SOHDG000000-00

MODEL: Outlet (3"~6")

OUTLET CONNECTION

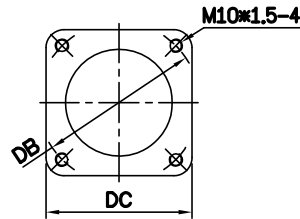

Model	mm		inch	
	DB	DC	DB	DC
1.5~3.7kW	98	89	3 7/8	3 1/2
5.5~7.5kW	127	112	5	4 1/8

OPTIONAL OUTLET ACCESSORIES

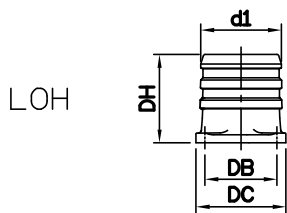

LOH	Dimensions-mm				kg	Dimensions-inch				b
	d1	DB	DC	DH		d1	DB	DC	DH	
LOH3-98	80	98	89	100	2	3	3 7/8	3 1/2	3 15/16	4
LOH3-127	80	127	112	110	2	3	5	4 7/16	4 5/16	4
LOH4-127	100	127	112	110	3	4	5	4 7/16	4 5/16	7
LOH6-127	150	127	112	172	5	6	5	4 7/16	6 3/4	11

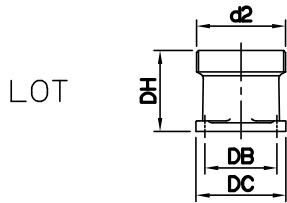

LOT	Dimensions-mm				kg	Dimensions-inch				b	Thread Available		
	d2	DB	DC	DH		d2	DB	DC	DH		Weight	PF	PT
LOT3-98	80	98	89	80	2	3	3 7/8	3 1/2	3 1/8	4	PF	PT	NPT
LOT3-127	80	127	112	85	2	3	5	4 7/16	3 3/8	4	PF	PT	NPT
LOT4-127	100	127	112	85	2	4	5	4 7/16	3 3/8	4	PF	PT	NPT
LOT6-127	150	127	112	140	4	6	5	4 7/16	5 1/2	9	PF	PT	NPT

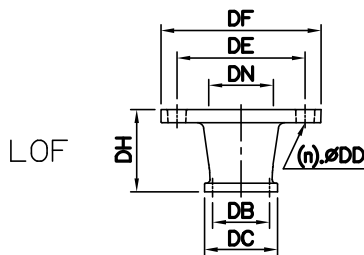

LOF	Dimensions-mm							kg	Dimensions-inch							b	(n)QTY
	DN	DB	DC	DD	DE	DF	DH		Weight	DN	DB	DC	DD	DE	DF		
LOF3-150-160*98	80	98	89	19	150~160	195	100	4	3	3 7/8	3 1/2	3/4	5 3/4~6 5/16	7 1/16	3 15/16	9	8
LOF3-150-160*127	80	127	112	19	150~160	195	110	7	3	5	4 7/16	3/4	5 3/4~6 5/16	7 1/16	4 5/16	15	8
LOF4-175-190*127	100	127	112	19	175~190	225	110	10	4	5	4 7/16	3/4	6 7/8~7 1/2	8 7/8	4 5/16	22	8
LOF6-240*127	150	127	112	23	240	280	140	14	6	5	4 7/16	7/8	9 1/16	11	5 1/2	31	8

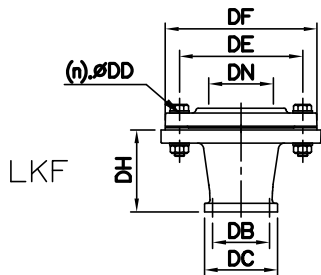

LKF	Dimensions-mm							kg	Dimensions-inch							b	(n)QTY	Thread Available	
	DN	DB	DC	DD	DE	DF	DH		Weight	DN	DB	DC	DD	DE	DF			DH	Weight
LKF3-150*98	80	98	89	15	150	185	100	8	3	3 7/8	3 1/2	9/16	5 3/4	7 5/16	3 15/16	18	8	PT	NPT
LKF3-150*127	80	127	112	15	150	185	110	8	3	5	4 7/16	9/16	5 3/4	7 5/16	4 5/16	15	8	PT	NPT
LKF4-175*127	100	127	112	15	175	210	110	10	4	5	4 7/16	9/16	6 7/8	8 3/4	4 5/16	22	8	PT	NPT
LKF6-240*127	150	127	112	23	240	280	140	20	6	5	4 7/16	7/8	9 1/16	11	5 1/2	44	8	PT	NPT

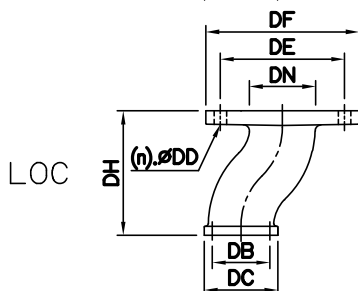

LOC	Dimensions-mm							kg	Dimensions-inch							b	(n)QTY
	DN	DB	DC	DD	DE	DF	DH		Weight	DN	DB	DC	DD	DE	DF		
LOC3-150*98	80	98	89	15	150	185	150	5	3	3 7/8	3 1/2	9/16	5 3/4	7 5/16	5 3/4	11	8
LOC3-150*127	80	127	112	15	150	185	180	6	3	5	4 7/16	9/16	5 3/4	7 5/16	7 1/16	13	8